

# Model 3005A Digital Insulation Resistance Tester

---

## *User Manual*

**Dear Customer,**  
Thank you for purchasing our  
**Model 3005A Digital Insulation Resistance Tester!**  
Please read this manual carefully before using the device.  
Keep this manual for reference.



**Amblyonix Industrial**  
Instrument Company  
20 Republic Road  
North Billerica, MA 01862





**Amblyonix**  
Industrial Instrument Company

# Table of Contents

<b>Before Using the Device</b>	<b>3</b>
<b>The Model 3005A Digital Insulation Resistance Tester</b>	<b>4</b>
Overview	4
How the Model 3005A Digital Insulation Resistance Tester works	4
Measuring Principle	5
<b>Product Information</b>	<b>5</b>
What's Included in the Box?	5
Model 3005A Digital Insulation Resistance Tester Structure	6
Model 3005A Digital Insulation Resistance Tester Features	7
Model 3005A Digital Insulation Resistance Tester Technical Specifications	8
Measuring Range and Accuracy	9
Voltage Range and Accuracy	10
<b>Using the Model 3005A Digital Insulation Resistance Tester</b>	<b>11</b>
Switching on the Device	11
Checking the Battery	11
Setting the Backlight	11
Setting the Alarm	12
Saving the Data	12
Reviewing the Data	13
Deleting the Data	13
<b>During the Test Procedures</b>	<b>14</b>
Using the Guard Terminal	14
<b>Test Procedures</b>	<b>15</b>
DC Voltage Test	15
AC Voltage Test	16
Insulation Resistance Test	17
Polarization Index (PI) and Dielectric Absorption Ratio (DAR) Tests	19
PI and DAR Functions	20
PI and DAR Differences	20
PI and DAR Applications	21
<b>After Test Procedures</b>	<b>22</b>
<b>After-Sales Services</b>	<b>23</b>

# 1. Before Using the Device

This manual describes the proper use of the **Model 3005A Digital Insulation Resistance Tester**. This device conforms to International Electrotechnical Commission standards (**IEC61010**) on design, production, and testing. For your safety, please read and follow the safety instructions and precautions properly before using this device.

Electrical Safety Symbols		
<b>Lightning bolt</b> 	<b>Double insulation</b> 	<b>Caution</b> 
This symbol indicates risks of high voltage, electric shocks, or live wires.	This symbol indicates that the device is protected by double or reinforced insulation.	This symbol indicates a warning to avoid potential risk or danger.
<b>IMPORTANT:</b> You must read the instructions whenever the safety symbols appear in the manual. You must pay attention to the safety symbols on the device.		

- You must use this device in accordance with the manual to avoid the risk of danger.
- You must use this device carefully to avoid possible electric shock and personal injury.
- Make sure that this device and accessories are in good condition before use.
  - \* You can only use this device when there are no damaged, exposed wires, or broken parts in testing cables or insulation layers.
- Make sure to fully insert the connector plugs into the correct interfaces of this device.
- You must not impose over 600V **AC** or **DC** voltage between the device and the circuit under test.
- To avoid explosions, you must not use this device in a flammable environment.
- You must not keep or store this device in a place with high temperature, moisture or condensation, or under direct sunlight.
- You must check the batteries regularly.
  - \* When the screen displays a low battery symbol, charge the battery in a timely manner to increase the life of the battery.
  - \* You must dispose of used batteries in a specified collection place accordingly.
- You must not disassemble this device without our company's permission.
  - \* We do not provide any maintenance or replacement warranty for device failure caused by disassembling equipment without our explicit written authorization.
  - \* We are not responsible for any physical or property damage caused by disassembly of the equipment without our permission.

## ***2. The Model 3005A Digital Insulation Resistance Tester***

### **2.1 Overview**

The **Model 3005A Digital Insulation Resistance Tester** is a lightweight and portable megohmmeter designed for high voltage insulation resistance tests. You can use this device to measure the insulation resistance of insulating materials, motors, cables, transformers, and electrical installations. This device gives you real-time results in ohms or megohms that can be stored or exported for future analysis. It has strong anti-interference and is indispensable for the following:

- Electrical systems
- Electric telecommunications
- Substation testing applications
- Metrology and computer rooms
- Oil fields
- Industrial enterprises
- Electromechanical installation and maintenance

The **Model 3005A Digital Insulation Resistance Tester** is an industrial tester designed to provide years of dependable service. This device is powered by an advanced lithium-ion battery and can perform hundreds of insulation resistance tests from a single charge. It has selectable functions that are programmable for measuring **DC** voltage, **AC** voltage, insulation resistance (**IR**), polarization index (**PI**), and dielectric absorption ratio (**DAR**).

### **2.2 How the Model 3005A Digital Insulation Resistance Tester works**

The insulation resistance (**IR**) quality of electrical systems deteriorates over time due to environmental conditions and the presence of electrical and mechanical stress. The performance and life of electrical systems depend on the insulation conditions. That is why it is vital to check the **IR** of electrical systems periodically. The **Model 3005A Digital Insulation Resistance Tester** generates a high voltage across the insulator to measure resistance. It safeguards electrical systems from abrupt current leakage in wires that lead to accidental damage, blown circuits, or electrical shocks.

### 2.2.1 Measuring principle

The **Model 3005A Digital Insulation Resistance Tester** generates a high voltage (**V**) that creates electron flow across the insulator. It measures the flowing current (**I**) and calculates the insulation resistance value (**R**) according to the formula, Resistance = Voltage/Current (**R=V/I**).

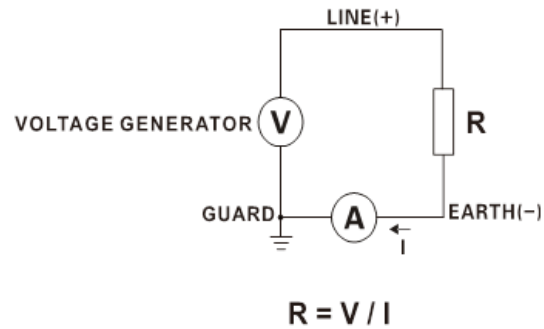

## 3. Product Information

### 3.1 What's included in the box?

This section shows what's inside the rugged aluminum case.

- 1 Digital insulation resistance tester
- 1 Red high-voltage test cable
- 2 High voltage test cables
- 1 Monitoring software CD
- 1 USB communication line
- 1 12.6V Battery
- 1 Charger
- User Manual
- Warranty Card



**Amblyonix**  
Industrial Instrument Company

## 3.2 Model 3005A Digital Insulation Resistance Tester Structure

This section shows the structure of the **Model 3005A Digital Insulation Resistance Tester**.

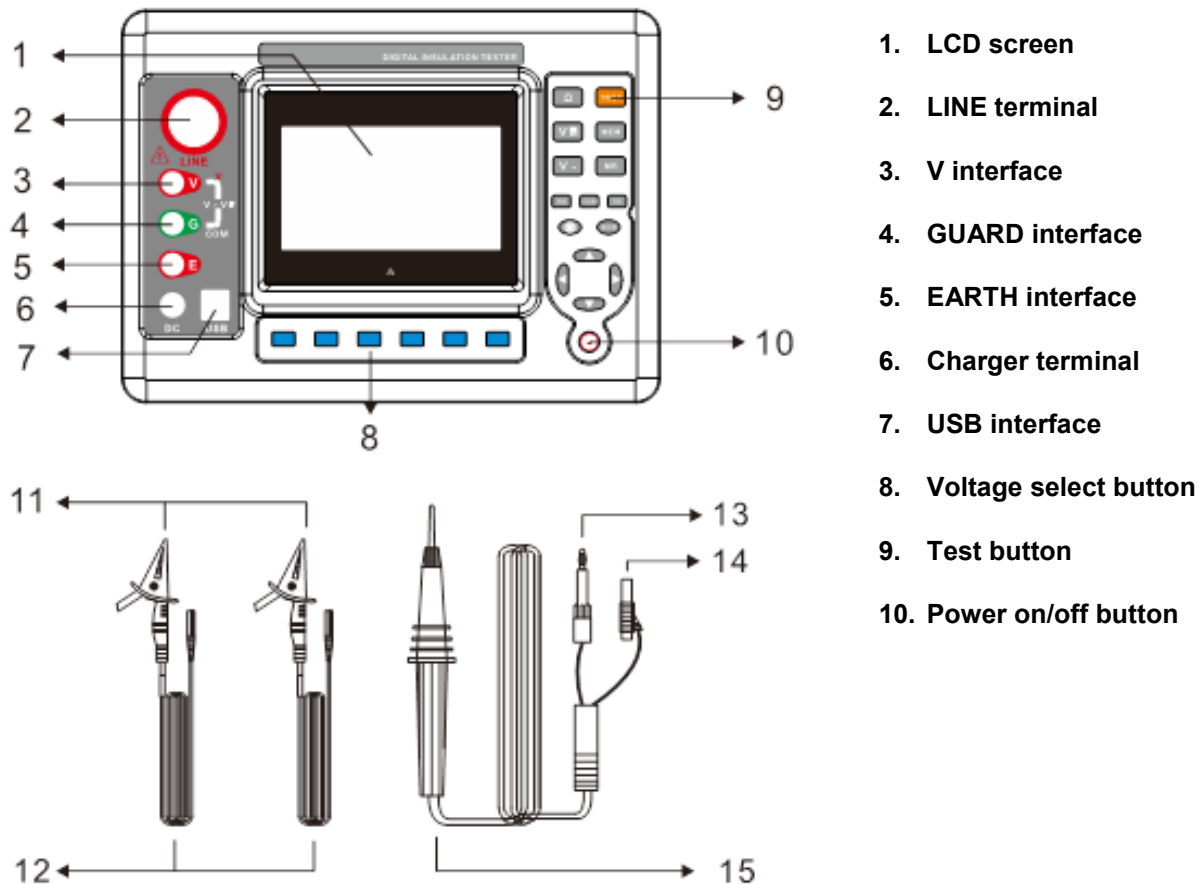

11. Safety alligator clips

12. Test cables (1 green, 1 black)

13. High voltage banana plug

14. Shielded cable connector

15. High voltage test cable



**Amblyonix**  
Industrial Instrument Company

### 3.3 Model 3005A Digital Insulation Resistance Tester Features

This section highlights the features of the **Model 3005A Digital Insulation Resistance Tester**.

#### **Excellent design**

The device is beautiful, upscale, and has a shockproof, dustproof, moisture-proof structure. It is ultra-lightweight, compact, and portable, but is powerful enough for industrial field use.

#### **Measuring voltage**

The device is compatible with different voltage ranges, ranging from 100V to 5000V, depending on the dielectric strength of the insulation.

#### **Multifunctional**

The device is suitable for insulation resistance tests and voltage tests. It can also measure dielectric absorption ratios and polarization indexes.

#### **Front-panel interactive interface**

The device is easy to use with a unique interactive interface that displays easy-to-read measurements and test routines.

#### **Display mode**

The device has a 4-bit large liquid crystal display (LCD) with high resolution.

#### **USB communication interface**

The device is equipped with a USB interface and software monitoring that allows uploading stored data to the computer, saving, and printing.

#### **Communication Line**

The device uses one USB communication line.

#### **Data storage**

The device is equipped with an onboard memory that can store 500 test results.

#### **Data review**

The device has a memory recall (**MR**) feature that allows the user to review stored data.

#### **Overload warning**

The device has an overload warning (**OL**) feature that warns the user when the measurement range exceeds the allowable range.

#### **Backlight feature**

The screen has a gray backlight feature that is suitable for use in dim places.

#### **Automatic shut-down**

The device shuts down automatically after 15 minutes of inactivity.

#### **Alarm feature**

The device is designed to alarm when the measured voltage value is greater than the alarm set value or the insulation resistance value is less than the alarm set value.

#### **Safety Regulations full compliance**

The device is equipped with strong anti-interference circuit architecture and is in full compliance with IEC 61010-1, IEC 1010-2-31, IEC 61557-1,5, IEC60529 (IP54) pollution grade 2, CAT III 300V.



### 3.4 Model 3005A Digital Insulation Resistance Technical Specifications

This table shows the technical specifications of the **Model 3005A Digital Insulation Resistance Tester**.

<b>Base conditions</b>	23°C±5°C, below 75%rh
<b>Test voltage ranges</b>	100V, 250V, 500V, 1000V, 2500V, 5000V
<b>Test voltage accuracy</b>	(±10%)
<b>Insulation resistance range (GΩ)</b>	0.01 MΩ – 2000 GΩ
<b>Insulation resistance resolution</b>	0.01 MΩ – 1 GΩ
<b>DC voltage range</b>	0 – 1000V
<b>DC voltage range resolution</b>	0.1V
<b>AC voltage range</b>	0 – 750V
<b>AC voltage range resolution</b>	0.1V
<b>Output short-circuit current</b>	≥5mA (5KV)
<b>Power supply</b>	12.6V rechargeable battery
<b>LCD screen size</b>	108mm × 65mm
<b>Instrument size</b>	L/W/H: 10.9 " × 9.0 " × 6.0 "
<b>Instrument weight</b>	6.0 lbs (including battery)
<b>Insulation resistance</b>	≥50MΩ (between measuring line and housing)
<b>Voltage withstand</b>	AC3kV/60Hz 1 minute
<b>Working temperature and humidity</b>	-10°C — +50°C<85%RH
<b>Storage temperature and humidity</b>	-15°C — +55°C<90%RH
<b>Test cables</b>	3m red high voltage test cable
	1.5m black high voltage test cable
	1.5m green high voltage test cable
<b>Power consumption</b>	Standby: 30mA Max (backlight off)
	Standby: 42mA Max ( backlight on )
	Measuring: 300mA Max (backlight off)



**Amblyonix**  
Industrial Instrument Company



## 3.5 Measuring Range and Accuracy

### 3.5.1 Insulation Resistance Range and Accuracy

This table shows the output voltage, measuring range, accuracy, and resolution for the insulation resistance (IR) test.

Test Function	Output Voltage	Measure Range	Accuracy	Resolution
Insulation Resistance	100V (±10%)	0 MΩ – 5 MΩ	±5%rdg±5dgt	0.01 MΩ
		5 MΩ – 50 MΩ	±5%rdg±5dgt	0.01 MΩ
		50 MΩ – 500 MΩ	±5%rdg±5dgt	0.1 MΩ
		0.5 GΩ – 5 GΩ	±10%rdg±5dgt	0.01 GΩ
		5 GΩ – 20 GΩ	±10%rdg±5dgt	0.1 GΩ
	250V (±10%)	0 MΩ – 10 MΩ	±5%rdg±5dgt	0.01 MΩ
		10 MΩ – 100 MΩ	±5%rdg±5dgt	0.1 MΩ
		100 MΩ – 1000 MΩ	±5%rdg±5dgt	1 MΩ
		1 GΩ – 10 GΩ	±5%rdg±5dgt	0.01 GΩ
		10 GΩ – 30 GΩ	±5%rdg±5dgt	0.1 GΩ
	500V (±10%)	0 MΩ – 20 MΩ	±5%rdg±5dgt	0.01 MΩ
		20 MΩ – 200 MΩ	±5%rdg±5dgt	0.1 MΩ
		200 MΩ – 2000 MΩ	±5%rdg±5dgt	1 MΩ
		2 GΩ – 20 GΩ	±5%rdg±5dgt	0.01 GΩ
		20 GΩ – 50 GΩ	±10%rdg±5dgt	0.1 GΩ
	1000V (±10%)	0 MΩ – 50 MΩ	±5%rdg±5dgt	0.01 MΩ
		50 MΩ – 500 MΩ	±5%rdg±5dgt	0.1 MΩ
		500 MΩ – 5000 MΩ	±5%rdg±5dgt	1 MΩ
		5 GΩ – 50 GΩ	±5%rdg±5dgt	0.01 GΩ
		50 GΩ – 100 GΩ	±10%rdg±5dgt	0.1 GΩ

Test Function	Output Voltage	Measure Range	Accuracy	Resolution
Insulation Resistance	2500V (±10%)	0 MΩ – 10 MΩ	±5%rdg±5dgt	0.01 MΩ
		10 MΩ – 100 MΩ	±5%rdg±5dgt	0.1 MΩ
		100 MΩ – 1000 MΩ	±5%rdg±5dgt	1 MΩ
		1 GΩ – 10 GΩ	±5%rdg±5dgt	0.01 GΩ
		10 GΩ – 100 GΩ	±5%rdg±5dgt	0.1 GΩ
		100 GΩ – 300 GΩ	±10%rdg±5dgt	1 GΩ
	5000V (±10%)	0 MΩ – 20 MΩ	±5%rdg±5dgt	0.01 MΩ
		20 MΩ – 200 MΩ	±5%rdg±5dgt	0.1 MΩ
		200 MΩ – 2000 MΩ	±5%rdg±5dgt	1 MΩ
		2 GΩ – 20 GΩ	±5%rdg±5dgt	0.01 GΩ
		20 GΩ – 200 GΩ	±5%rdg±5dgt	0.1 GΩ
		200 GΩ – 2000GΩ	±10%rdg±5dgt	1 GΩ

**Note:** These are the common electrical unit conversions.

**1 TΩ (Tera ohm) = 1000 GΩ = 10<sup>12</sup>Ω**

**1 GΩ (Giga ohm) = 1000 MΩ = 10<sup>9</sup>Ω**

**1 MΩ (Mega ohm) = 1000 KΩ = 10<sup>6</sup>Ω**

### 3.5.2 Voltage Range and Accuracy

This table shows the measuring range, accuracy, and resolution for the **DC** and **AC** voltage tests.

Test Function	Measure Range	Accuracy	Resolution
<b>DC Voltage</b>	DC 0.0V — 1000V	±1.5%rdg±3dgt	0.1V
<b>AC Voltage</b>	AC 0.0V — 750V	±1.5%rdg±3dgt	0.1V

## 4. Using the Model 3005A Digital Insulation Resistance Tester

This section provides steps on how to use the **Model 3005A Digital Insulation Resistance Tester**.

### 4.1 Switching on the Device



Press  to turn the device on.

After turning the device on, Automatic Power Off (**APO**) appears in the lower corner of the screen.

The device shuts down automatically after 15 minutes of inactivity.

### 4.2 Checking the Battery



After turning the device on, check the battery level. When the battery is low, the battery indicator  blinks and the backlight turns on and off repeatedly. Charge the battery in a timely manner to ensure measurement accuracy and to ensure long battery life.

### 4.3 Setting the Backlight

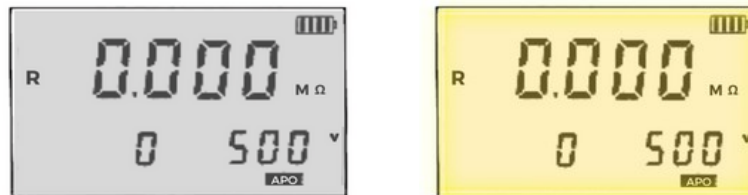

Press  to switch on or switch off the backlight.

Use the backlight function during test procedures in dim places.

## 4.4 Setting the Alarm

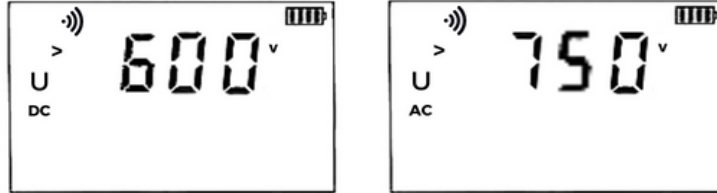

1. Press to switch on or switch off the alarm function.
2. Press **MODE** to set the alarm value setting mode.
3. Press to select the resistance value setting.
4. Press to select **DC** voltage setting.
5. Press to select **AC** voltage setting.
6. Scroll through , , , to select the desired value.
7. Press **MODE** to save and exit.

If...	And...	Then...
you switched on the alarm function	the measured voltage value is greater than the critical set value	The LCD screen flashes the  symbol and emits a beep-beep-beep alarm sound.
	the insulation resistance value is less than the critical set value	





## 4.5 Saving the Data



1. Press **MEM** to record the current data after the test.  
The LCD screen displays the **FULL** symbol if the storage is full.
2. Press **MEM** to save and exit.

## 4.6 Reviewing the Data



1. Press **MR** to enter the review data mode.  
The LCD screen displays the **MR** symbol.
2. Scroll through , , ,  to select the data that you want to review.
3. Press **MEM** to save and exit.

Note: If there is no stored data, the LCD screen displays the **NULL** symbol.

## 4.7 Deleting the Data



1. In the data review state, press **CLEAR** to enter data deletion mode.
2. Press **NO** to return to the data review state.
3. Press **YES** to delete the stored data.



**Amblyonix**  
Industrial Instrument Company

## 5. During the Test Procedures

This section provides safety instructions during the test in a live working environment. Please read and follow the instructions properly to ensure safe and proper use of this device.



- You must wear high-voltage insulating gloves during the test procedures.
- You must not use high-frequency signal generators like mobile phones and others to avoid error when measuring.
- You must not touch the bare conductors and circuits under test.
- You must not use this device when there are damaged, exposed, or broken parts in testing wires or insulation layers.
- You must not charge batteries or perform data transmission uploads while performing an insulation resistance measurement.
- You must pay attention to measuring ranges and specific environmental conditions during the usage of this device.
- You must not use this device when the battery cover is open, especially during adverse weather conditions.
- This device generates a high voltage. Make sure to connect the test cables properly. Before pressing the test button, remove your hands from the test cables to avoid the risk of electric shock.
- When the test is complete, wait for one minute before removing the test cables.

### 5.1 Using the Guard Terminal



When measuring the insulation resistance of a cable, the leakage current of the cable surface is in parallel to the current that passes through the interior of the insulation. Then, the current converges resulting in an error in the insulation resistance value. To avoid this occurrence, use a protection wire guard to guard the leakage current, as shown in the figure below. After connecting to the guard terminal, the leakage current does not flow through the indicator and the insulator accurately measures the insulation resistance. You must use the guard test cable to connect to the guard terminal.

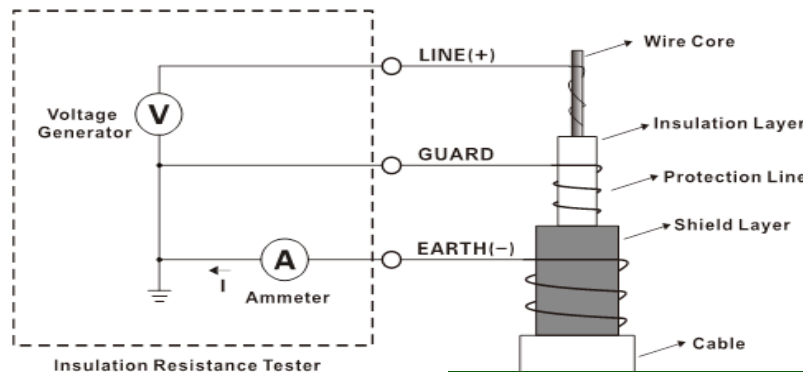

## 6. Test Procedures





This section provides important instructions on how to perform **DC** voltage, **AC** voltage, insulation resistance (**IR**), polarization index (**PI**), and dielectric absorption ratio (**DAR**) tests.

### 6.1 DC Voltage Test

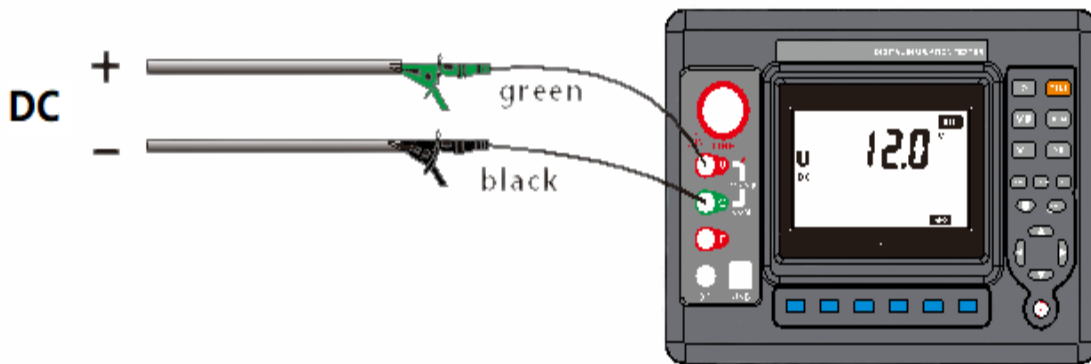

The input **DC** voltage must not exceed 1000V.



1. Press  to turn the device on.
2. Press  to switch to **DC** voltage test mode.
3. Connect the green connector plug into the  interface and then connect the safety alligator clip to the unit under test.
4. Connect the black connector plug into the  interface, and then connect the safety alligator clip to the unit under test.





The LCD screen displays the real-time **DC** voltage value.

## 6.2 AC Voltage Test

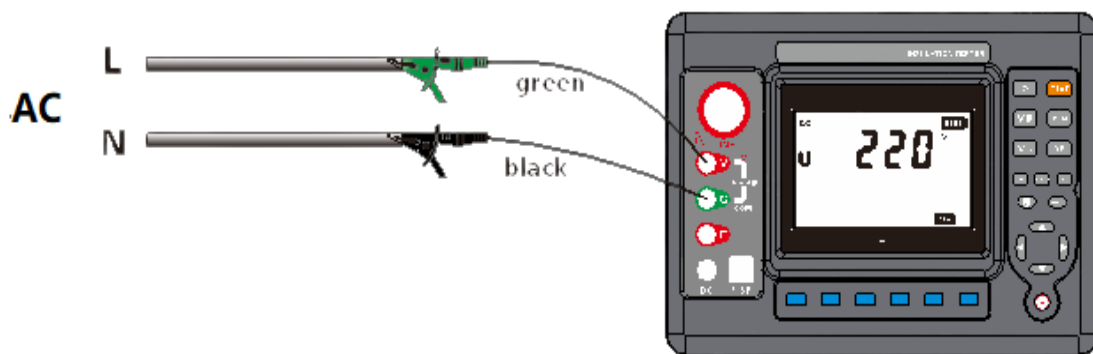

The input **AC** voltage must not exceed 750V.



1. Press  to turn the device on.
2. Press  to switch to **AC** voltage test mode.
3. Connect the green connector plug into the  interface and then connect the safety alligator clip to the unit under test.
4. Connect the black connector plug into the  interface, and then connect the safety alligator clip to the unit under test.

The LCD screen displays the real-time **AC** voltage value.



### 6.3 Insulation Resistance Test



- You can only perform insulation resistance tests on non-energized circuits.
- Before the insulation resistance test, check if the test circuit wiring is in good condition and if the circuit under test is energized. An energized circuit can damage the instrument and affect measurement accuracy.



- Make sure to connect the black grounding wire to the grounding port of the circuit under test.
- After the test, do not touch the circuit immediately. Wait until the discharge is complete before touching the circuit; stored charge can cause electric shock.
- To ensure measurement accuracy, do not twist the test cables together.

The table shows the guaranteed temperature and humidity of the insulation resistance accuracy.

Insulation resistance range	Guaranteed humidity value of the insulation resistance	Guaranteed temperature of the insulation resistance accuracy
0 $\Omega$ – 100 M $\Omega$	<85% RH (No condensation)	23°C±5°C
101 M $\Omega$ – 20 G $\Omega$	<75% RH (No condensation)	
21 G $\Omega$ – 1000 G $\Omega$	<65% RH (No condensation)	

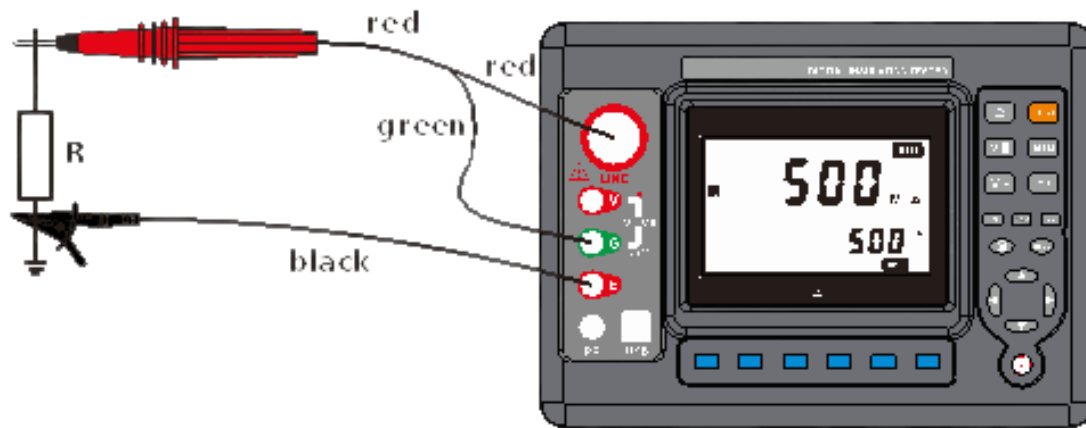

1. Press **Ω** to start.
2. Press **100V**, or **250V**, or **500V**, or **1KV**, or **2.5KV**, or **5KV** to select the voltage value.
3. Connect the black connector plug into the **E** interface, and then connect the safety alligator clip to the grounding port of the circuit under test.
4. Connect the banana plug of the red high voltage test cable into the **⊕** terminal, and then connect the high-voltage probe to the circuit under test.
5. Connect the shielded cable connector into the **⊖** interface.
6. Press **TEST** to start the test.  
 The device emits an audible beep during testing.  
 The LCD screen displays the real-time insulation resistance value.
7. After the measurement is complete, press **MEM** to record the current display data.  
 The device saves the measured display data in storage automatically.

## 6.4 Polarization Index (PI) and Dielectric Absorption Ratio (DAR) Tests



- You can only perform **PI** and **DAR** tests on uncharged circuits.
- Before the test, check if the test circuit wiring is in good condition and if the circuit under test is energized.

1. Press to start.
2. Press , or , or , or , or , or to select the voltage value.
3. Press to set the corresponding mode.

The LCD displays

- **10:01m** - polarization index mode,
- **60:15S** - absorption mode 15-second mode, and
- **60:30S** - absorption mode 30-second mode.

The LCD does not display small values for the insulation resistance measurement mode.



Polarization index mode



Absorption ratio 15 seconds mode



Absorption ratio 30 seconds mode

4. Connect the black connector plug into the interface, and then connect the safety alligator clip to the grounding port of the circuit under test.
5. Connect the banana plug of the red high voltage test line into the terminal, and then connect the high-voltage probe to the circuit under test.
5. Press to start the test.

The LCD displays the real-time **PI** and **DAR** values.

7. Press to view the divisor of the **DAR** or **PI** value, the value of 60 in “60:15S” mode.
8. Press to view the dividend of the **DAR** or **PI** value, the value of 15 in “60:15S” mode.
9. Press or to return.

### 6.4.1 Polarization Index (PI) and Dielectric Absorption Ratio (DAR) Functions

The **Model 3005A Digital Insulation Resistance Tester** automatically calculates the **PI** and **DAR** values. The function of the **PI** and **DAR** tests is to check if the leakage current of the insulator has increased. The results indicate the change in insulation resistance after the measured circuit withstands the measured voltage.

### 6.4.2 Polarization Index (PI) and Dielectric Absorption Ratio (DAR) Differences

**DAR** refers to the short-term **IR** test that you can perform to increase the leakage current while the applied voltage polarizes the atoms in the insulation. You can measure the **IR** when the leakage current stabilizes within one minute. **DAR** test is suitable for general insulation testing such as house wiring insulation, tool handles, and other equipment which can be tested in a short time. You can perform a **PI** test when **DAR** is not enough to reflect the long-term process of absorption. **PI** test is suitable for insulation with higher index or large capacities such as transformers, generators, cables, and other electrical equipment. The ratio between the insulation resistance (**R10min**) at 10 minutes and the insulation resistance (**R1min**) at one minute describes the entire process of insulation absorption.

The **Model 3005A Digital Insulation Resistance Tester** calculates the **PI** and **DAR** values by:

<b>Polarization Index</b>	$\frac{R\ 10\ Min}{R\ 1\ Min}$	<b>R10Min</b> = resistance value measured by the voltage applied for 10 minutes
		<b>R1Min, R60Sec</b> = resistance value measured by the voltage applied for 1 minute
<b>Absorption Ratio</b>	$\frac{R\ 60\ Sec}{R\ 15\ Sec}$	<b>R15Sec</b> = resistance value measured by the voltage applied for 15 seconds
<b>Absorption Ratio</b>	$\frac{R\ 60\ Sec}{R\ 30\ Sec}$	<b>R30Sec</b> = resistance value measured by the voltage applied for 30 seconds

**Note:** You can select between **15** seconds and **30** seconds **DAR** calculation time, depending on the index capacity of the circuit under test.



### 6.4.3 Polarization Index (PI) and Dielectric Absorption Ratio (DAR) Applications

In engineering, **IR**, **PI**, or **DAR** reflect the degree of moisture in the insulation of generators, oil-immersed power transformers, and other equipment. The **PI** and **DAR** values decrease when the insulation gets wet. It is an important indicator of whether the insulation is affected by moisture. Sometimes the insulation has obvious defects, but the **PI** and **DAR** values remain good. For example, the insulation breaks down under high voltage, but the **PI** and **DAR** values are still good. In such a case, you cannot use **PI** and **DAR** tests to find other local insulation defects, other than moisture and dirt.

The chart shows the relationship between insulation resistance and time.

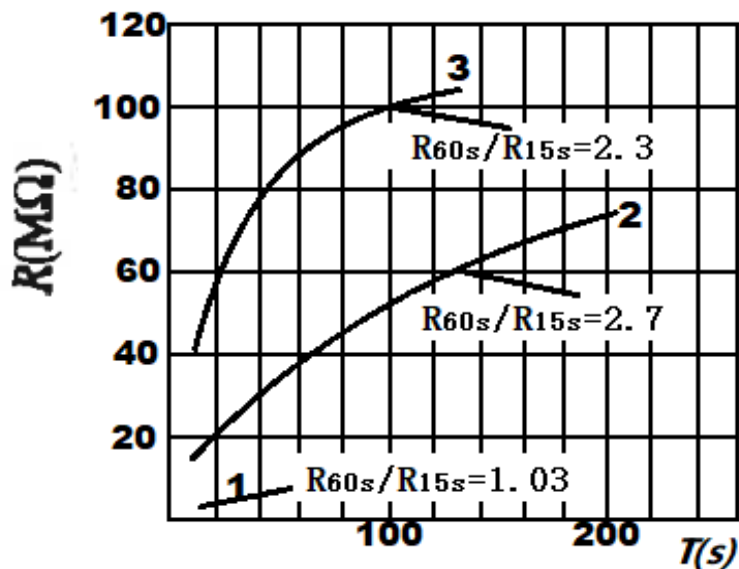

1. 15 degrees Celsius before drying
2. 73.5 degrees Celsius at the end of the drying
3. 27 degrees Celsius after running for 72H

The table shows the **PI** reference judgment value:

<b>Polarization Index</b>	<b>Above 4</b>	<b>4 – 2</b>	<b>2.0 – 1.0</b>	<b>Below 1.0</b>
<b>Judgment</b>	<b>Best</b>	<b>Good</b>	<b>Deserves attention</b>	<b>Bad</b>

The table shows the **DAR** reference judgment value:

<b>Absorption ratio</b>	<b>Above 1.4</b>	<b>4 – 2</b>	<b>1.25 – 1.0</b>	<b>Below 1.0</b>
<b>Judgment</b>	<b>Best</b>	<b>Good</b>	<b>Deserves attention</b>	<b>Bad</b>

## ***7. After Test Procedures***



- You must not touch the circuit immediately after the test. Wait until the discharge is complete before touching the circuit; stored charge can cause electric shock.
- When replacing the battery, remove the test cables from the front panel, and switch **OFF** the device.
- When cleaning the instrument, use a soft cloth to remove dust or dirt.
- You must not keep or store this device in a place with high temperature, moisture or condensation, or under direct sunlight.

## ***8. After-Sales Services***

The **Model 3005A Digital Insulation Resistance Tester** is under warranty for a period of one year from the date of purchase. In situations where warranty service is required, you must contact our After-sales department or visit our website for more information.

### **Warranty inclusions:**

- Replacement of Parts
- Maintenance
- Technical Services

### **Warranty conditions:**

- We do not provide maintenance and replacement warranty for device failure caused by disassembling equipment without our explicit written authorization.
- We are not responsible for any physical or property damage caused by the following:
  - \* Negligence
  - \* Abuse
  - \* Misuse
  - \* Improper installation

**Amblyonix Industrial**  
Instrument Company  
20 Republic Road  
North Billerica, MA 01862

